

4KW Air Parking Heater

Technical Description, Installation, Operation and Maintenance Instructions

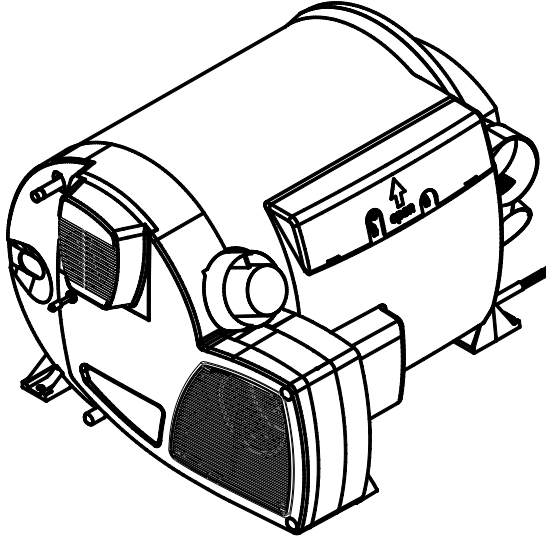

Production Type

Diesel electric DC12V/220VAC

Diesel electric DC12V/110VAC

Gasoline electric DC12V/220VAC

Gasoline electric DC12V/110VAC

Foreword

Thank you for using the parking heater

This manual describes the technical description, installation, operation and maintenance instructions for the parking heater. To ensure the correct use of the heater please read this manual carefully before installation and use. Please keep it properly after reading it. For review.

Note:

- The contents of this manual are subject to change without prior notice, but the instructions are guaranteed to be consistent with the products purchased.
- we try our best to express the problems that users should know through the instructions. If you have questions or find something wrong, please contact us directly.
- When the user unpacks for the first time, check the main unit and accessories against the packing list. If you find any problems, please contact the dealer immediately.
- If there is a problem in use, please contact the company's marketing department or our authorized customer service station. We will be happy to help you.

Note:

Must be installed and used in accordance with the requirements of the manual to ensure long-term use of the product!

Subject to Change

1.Application

FJH-4/1C-E Model air heated parking heater (hereinafter referred to as the heater) is a special heater for RV that integrates hot water and warm air. It can provide hot water for living while heating the passengers. This heater is allowed to be used during driving.

2. Main Technical Data

Rated Voltage	DC12V	
Operating Voltage Range	DC10.5V~16V	
Short-term Maximum Power	8-10A	
Average Power Consumption	1.8-4A	
Fuel type	Diesel/Petrol	
Fuel Heat Power (W)	2000	4000
Fuel Consumption (g/H)	240/270	510/550
Quiescent current	1mA	
Warm Air Delivery Volume m3/h	287max	
Water Tank Capacity	10L	
Maximum Pressure of Water	2.8bar	
Maximum Pressure of System	4.5bar	
Rated Electric Supply Voltage	~220V/110V	
Electrical Heating Power	900W	1800W
Electrical Power Dissipation	3.9A/7.8A	7.8A/15.6A
Working (Environment)	-25℃~+80℃	
Working Altitude	≤5000m	
Weight (Kg)	15.6Kg (without water)	
Dimensions (mm)	510×450×300	
Protection level	IP21	

Table 1

3.Function

Here are three options for the heater according to its working mode:

--Hot water mode

If you only need hot water, please select the hot water working mode. In the hot water working mode, the fuel mode or utility mode is used to heat the water tank. The water tank temperature can be set to 40 ℃ or 60 ℃. Since the temperature of the water tank is not uniform, the set temperature is the average water temperature of the water tank.

In the fuel oil mode, the heater operates with 2kW power by

boiling water alone, and stops heating once the set temperature is reached.

--Warm air mode

If you only need warm air to heat the interior of the RV, please select the warm air working mode,

--Hot water heating mode

In the hot water heating mode, the heater can be used to heat the room and hot water at the same time,

When the ambient temperature is lower than 3 ℃, please empty the water stored in the water tank to avoid freezing the water tank.

There are three energy modes for this heater:

--Fuel mode

The heater automatically adjusts the power.

--Electrical mode

The heater also has the function of heating with mains power, and the 900W or 1800W heating mode is manually selected according to the power supply capacity of the RV camp.

--Mixed mode

The Mixed mode includes fuel and 900W power, fuel and 1800W power.

4. Safety work environment

Safe working environment

--The heater can only be operated by the special control switch configured by the company.

--Danger of toxic exhaust gas: if the vehicle is parked in an enclosed room, the exhaust gas of the heater may be toxic in an enclosed space (such as a garage and a maintenance workshop). Therefore, the heater should be turned off in the enclosed space and the timing operation that may be started automatically should be turned off.

--Thermal sensitive objects (such as spray cans) or flammable materials / liquids cannot be stored in the same compartment as the heater, because in some cases, the area may be affected by high temperature.

--The outlet of warm air shall be away from inflammables and shall not block the outlet of warm air.

--The opening of circulating air inlet and the space around the heater must not be restricted by obstacles so that the heater will not overheat.

--At all times, keep the exhaust pipe, exhaust cap (inlet and outlet) and combustion air inlet free from pollution (snow mud, ice, leaves, etc.).

--The heated wall surface and exhaust gas around the exhaust hood may cause burns. Do not touch the area of the wall around the exhaust hood, and do not lean any object against the wall of the exhaust hood or the vehicle body.

Obligations of the operator / owner

Obligations of the operator / vehicle owner -- the vehicle owner is responsible for filling the heater container with water and maintaining it.

--The owner has the responsibility to operate the heater

correctly.

--The fuel system must comply with the national technical and administrative regulations and the national legislation and regulations.

--Check the water pipe regularly. If the water pipe is broken, please replace it.

--If the water heater is not in use, drain the water in the water heater to avoid the risk of frost. The company will not maintain or compensate for the damage caused by frost.

Safe operation

--Make sure that the vehicle is well ventilated. When the heater is started, there may be some smoke or smell because of dust or dirt, especially if the heater has not been used for a long time.

--The integrity and close cooperation of the exhaust double pipes must be checked regularly, especially at the end of the long-distance travel, and the installation of the device and the exhaust cap must also be checked.

--When cleaning the vehicle, do not spray water directly into the smoke exhaust cap.

5.Heater installation

The typical installation of the heater is shown in figure1.

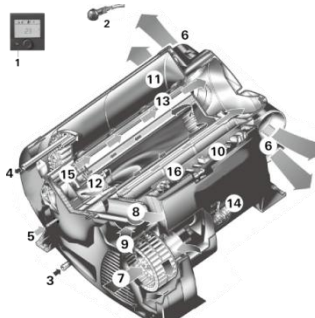

- 1-LCD switch
- 2- External temperature sensor
- 3-Cold water inlet
- 4-Hot water outlet
- 5-Fuel connection
- 6-Warm air outlets
- 7-Circulated air intake
- 8-Exhaust discharge
- 9- Combustion air inlet
- 10-Electronic control unit
- 11-Water container
- 12-Burner
- 13-Heat exchanger
- 14-Power electronic
- 15-Heating elements
- 16-Overheating switch

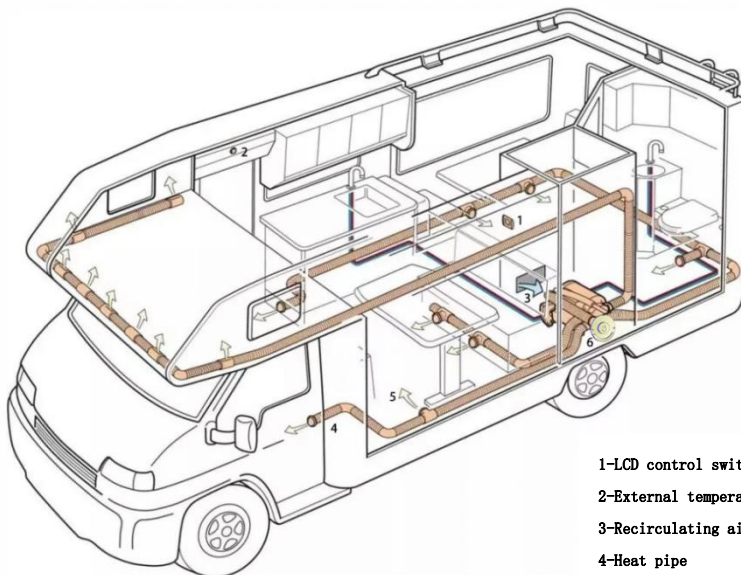

- 1-LCD control switch
- 2-External temperature sensor
- 3-Recirculating air inlet (minimum 150cm²)
- 4-Heat pipe
- 5-Heat outlet
- 6-Smoking cowl

Figure 1

★ **Must be installed and repaired by professionals authorized by the company!**

The company does not bear any responsibility for the following acts:

- Modified heater and accessories
- Modification of exhaust lines and accessories
- Do not follow the operating installation instructions
- Do not use our company's special accessories

Heater installation Figure 3.

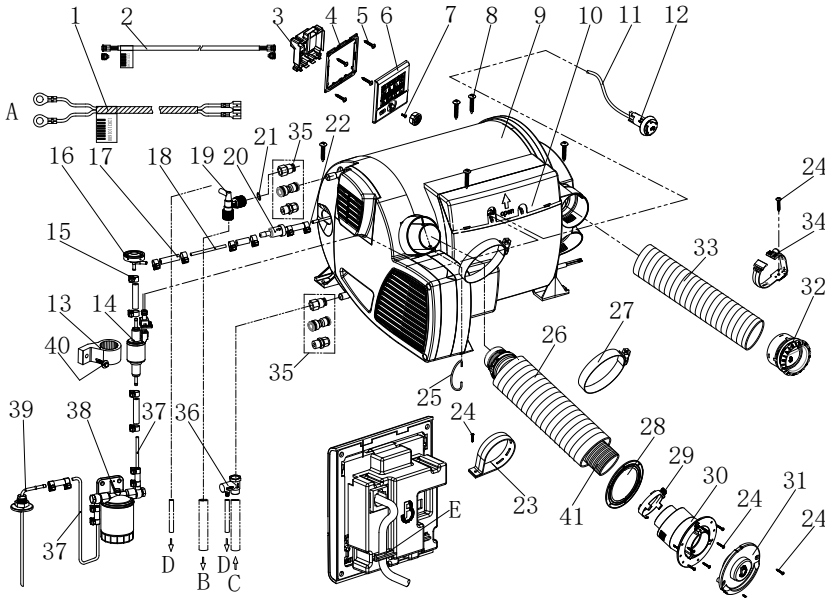

Figure 3

- 1_12V Power cord 2_LCD switch Lead wire 3_LCD switch back cover 4_LCD switch bracket 5_Self-tapping screw M3*10
 6_LCD control switch 7_Cross countersunk head flat tail self-tapping screw M3*6 8_Self-tapping screw ST5*25
 9_Heater 10_Controller cover 11_External temperature sensor lead wire 12_External temperature sensor
 13_Fuel pump connector 14_Fuel pump 15_Fuel pipe clamp($\phi 9-11$)16_Damper 17_Fuel pipe connector
 18Fuel pipe (transparent,from heater to fuel pump) 19_ Exhaust valve (option and quick connector G1/2 inner wire- ϕ 10 supporting use)
 20_no return valve21_Gasket (optional for use with exhaust valve figure 3-19)22_Fuel pipe clamp($\phi 8-10$) 23_Intake pipe mounting clamp
 24 Self-tapping screw ST3.5 \times 25 25_Fixing hook 26_Air intake pipe 27_German type clamp 28_Sealing rubber spacer 29_(Exhaust pipe) clamp 30_Intake and exhaust combine cowl 31_Intake and exhaust combine cover 32_Air outlet 33_Hot air ducting 34_Ducting clamp 35_Option (two types of reducer quick connector: G1/2 inner wire- ϕ 10, ϕ 10-12 , a ferrule connector: G1/2 outer wire- ϕ 10)
 36_Pressure reducing valve (option)37_Nylon oil pipe (blue, oil tank to oil pump) 38_Filter(only diesel) 39_Fuel suction pipe 40_Self tapping self drilling screw ST5.5*30 41_Exhaust pipe
 A_Connect to 12V Battery B_ connect to water equipment C_ connect to system water tank
 D_Flow out of the car E_Hook, clamp LCD switcher cord

The installation position of heater shall be load-bearing floor and double floor.

If there is no suitable floor, it can be made of plywood first make a bearing surface.

★ the heater must be firmly fixed to the mounting surface with screws, prevent the fuel pipeline from being damaged during the driving of the vehicle and cause danger danger.

According to the actual installation, only three screws can be installed. Two die cast aluminum fixing screws are fixed, and then one plastic the material can be fixed at right angles.

In order to ensure the uniform heat distribution of the heater, the heater shall be installed in the middle as far as possible, so that all heating pipes are as long as possible.

No cover is allowed to add to the heater surface.

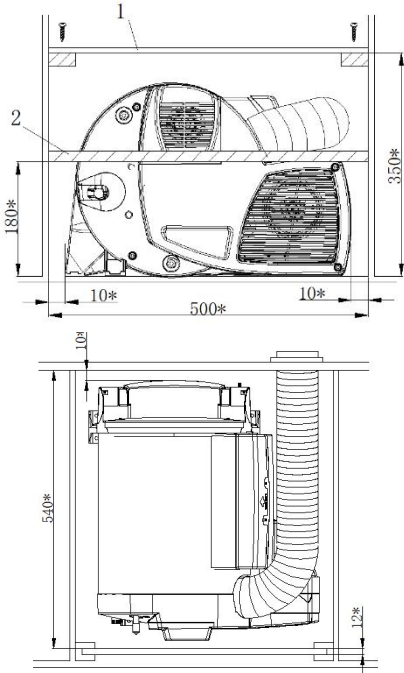

Figure.4

The dimension with * in Fig. 4 is the minimum dimension, leaving enough space for connecting fuel, water pipe and other accessories.

The upper cover plate of the heater compartment is fixed with screws. In order to prevent accidental loosening of the heater, it is necessary to install a solid batten 180mm from the floor at the fixed position of the heater perpendicular to the driving direction. The batten can be pasted with a buffer spacer (min. 30 * 50mm) (Fig. 4-1).

Thermal sensitive objects and flammable objects should be placed away from the heater.

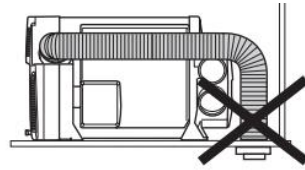

Figure. 5

★ the smoke exhaust cap (air inlet and exhaust outlet) must be placed on the side wall or top plate.

There is no ventilation window within 300mm and no oil filler or oil tank respirator within 500mm in the area where the exhaust hood is arranged.

If the smoke exhaust cap is installed under the window that is close to or can be opened, a window switch shall be installed to ensure that the heater is automatically closed when the window is opened to prevent exhaust gas from entering the vehicle.

Installation of intake and exhaust pipe

The exhaust pipe is inserted in the intake pipe. The length of the intake and exhaust pipe is shown in Fig. 6, with a minimum of 60cm and a maximum of 100cm. The smoke exhaust cap is only allowed to be 20cm below the exhaust outlet, otherwise it will cause bad combustion.

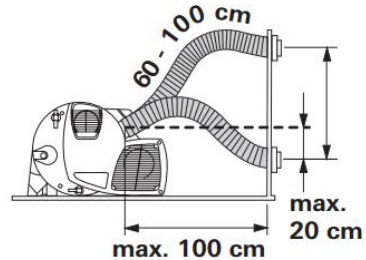

Figure.6

After the intake and exhaust pipes are inserted through the through holes, if it is necessary to shorten a section, the exhaust pipe shall be slightly shorter than the intake pipe. Avoid excessive expansion or tension on the exhaust pipe.

The Exhaust Cowl (air inlet and outlet) Installation

Select a flat mounting surface so that combustion air can enter from all sides. Drill a ϕ 83 holes are sealed with seals (Fig. 8-8), and the plane faces the smoke exhaust cap. Before installing the exhaust pipe, wear the exhaust pipe fixing clip (Fig. 8-3). Pay attention to the installation according to the upward sign of the smoke exhaust cap.

The 20mm end of the exhaust pipe should be compressed, not straightened. Insert the exhaust pipe into the interface of the exhaust cap (Fig. 8-10) as deep as possible. Try to put the exhaust pipe fixing clip on and tighten it.

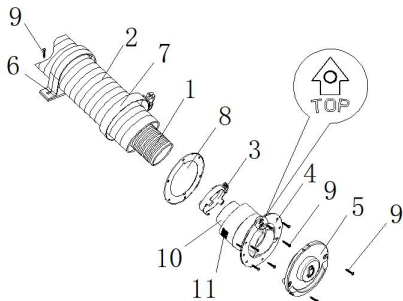
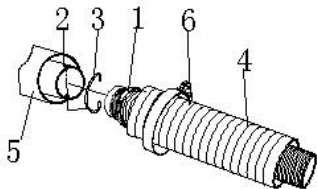

Figure.8

Put the intake pipe (Fig. 8-2) onto the teeth of the smoke exhaust cap (Fig. 8-11). Put on the fixing clip of the intake pipe (Fig. 8-7) and tighten it. Fix the smoke exhaust cap with 6 screws (Fig. 8-9), and fix the smoke exhaust cap cover with 2 screws.

The intake and exhaust pipes can be fixed to the side wall with fixing clips (Fig. 8-6).

Install the intake and exhaust pipes to the heater



The 20mmr Figure.9 Fig. 9-1) should be compressed, not straightened. Install the exhaust pipe into the exhaust port of the main engine (Fig. 9-2), and use the fixing hook (Fig. 9-3) to pass through the two holes of the exhaust port of the main engine and snap into the ring groove of the exhaust pipe for fixation.

Put the intake pipe (Fig. 9-4) onto the intake port (Fig. 9-5) of the main engine. Put on the fixing clip of the intake pipe (Fig. 9-6) and tighten it.

Warm Air Intake

The warm air intake is sucked by the heater. There must be an opening with a total area of not less than 150cm² between the room and the heater.

Ensure that the warm air intake is not polluted by the exhaust gas of the engine or heater. If necessary, take structural isolation measures.

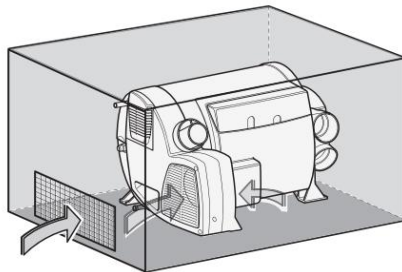

Figure. 10

Warm Air Distribution

Most of the warm air is imported into the floor area of the living compartment through the bellows.

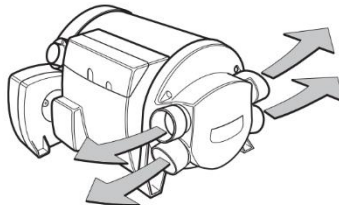

Figure. 11

4 air outlet connections on the heater ϕ 65 bellows, only pressure pipes meeting the quality requirements of bilefu shall be used. Other pipes that do not meet our quality standards (especially wind resistance, pipe diameter and number of corrugations) shall not be used.

If the heating pipe must withstand a considerable amount of bending in a limited space, we recommend using a 90° elbow (single option).

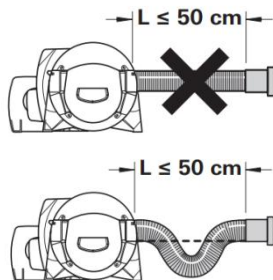

Figure. 12

When the pipe length is less than 2m, the air outlet shall not be installed at a place higher than the connection port of the warm air pipe. When the length of the pipe is less than 50 cm, the pipe must form a siphon between the connector and the outlet. These measures prevent the vehicle from undesired heating due to convection (cowling effect) during summer operation.

- ★ The heating pipe must be firmly inserted into the connection port.
- ★ In order to obtain the best warm air distribution, bilifu requires that all four warm air outlets of the heater must be used.
- ★ The cross section of the heating pipe shall not be reduced due to pipe connection or the like. That is to say, the number of outlets of the warm air duct (Fig. 3_32) shall not be less than four to ensure that more than four warm air outlets are open.

Fuel system connection

The fuel is extracted from the vehicle fuel tank or supplied from the special fuel tank. The fuel is delivered and the fuel supply quantity is adjusted by the special oil pump (provided by the manufacturer). It is not allowed to extract the fuel from the return system of the vehicle engine or the downstream of the delivery pump inside the vehicle. Please only use the fuel hoses and pipes within the scope of delivery for installation.

The fuel shall meet national standards

GB19147-2013 diesel standard for vehicles

Winter fuel should meet the low temperature requirements brand, do not allow the use of biofuels.

Fuel line system

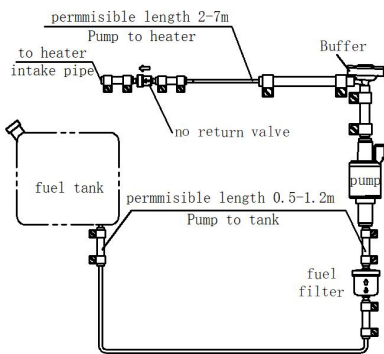

Figure. 13

Installation of oil pipe

The oil delivery pipe must use the accessories of this machine, that is, nylon hose with good light resistance and thermal stability. Allowable fuel pipe length: the fuel pipe length from the oil tank to the oil pump is 0.5 ~ 1.2m, and the fuel pipe length from the oil pump to the main engine is 2 ~ 7m. As shown in Figure 13.

Safety Regulations for Fuel Pipe

The fuel hose and pipeline must be cut to a certain length with a hose cutter or sharp knife. The cut area must not be compressed and there must be no burr. The fuel pipeline must be firmly connected to prevent damage and / or noise caused by vibration (it is recommended that the distance between fixing points is about 50cm). The fuel pipeline must be protected from mechanical damage. The fuel pipeline must be laid so as not to rotate the vehicle. The stability such as engine operation is adversely affected. Protect the fuel carrying parts from the high temperature that may affect the operation (use a suitable glass fiber lined aluminum thermal protection hose). Do not set or fix the fuel pipe near the heater or the exhaust pipe of the vehicle engine. If the lines cross, keep sufficient distance from the hot parts, and provide thermal radiation protection plates if necessary. The installation position of oil pipe shall be able to prevent the impact of flying stones, and shall be away from the heating parts of the vehicle. If necessary, protective devices shall be installed.

Installation of oil pump

The oil pump shall be fixed by the oil pump fixing ferrule (rubber). The oil outlet of the oil pump shall be inclined upward, and the installation angle shall be selected within the range of 15 ° ~ 35 ° (as shown in FIG. 14). When conditions permit, the oil pipe from the oil pump to the heater main engine shall rise gradually. To prevent the oil pump from being heated (the maximum operating temperature is 40 °C), do not install it near the exhaust pipe.

The height difference between the fuel level and the oil pump and the height difference between the oil pump and the oil inlet of the main engine will generate pressure (or suction) in the oil path, so these dimensions shall meet the requirements of Figure 14 .

Connection between heater and oil pump

The oil pipe from the oil pump to the main engine shall be upward as far as possible, and marked on the appropriate position on the vehicle floor for passing through. The hole for connecting the fuel pipe and the oil pump cable. Before drilling, be sure to check the hidden cables, fuel pipes, frame sections, etc! Then seal the edge of the opening on the vehicle floor with the underbody protector. In order to prevent the cable of oil pipe and oil pump from being cut, please add the lead-in bushing or section edge protection material. The oil pipes shall be bound at suitable places for fixation, and the binding distance shall not be greater than 50cm. The connection between the oil pipe and the oil pump, the main engine and the oil tank (oil nozzle) shall use the oil pipe connector provided by the machine and be clamped with the oil pipe clamp. Prevent air bubbles at the connection (FIG. 15).

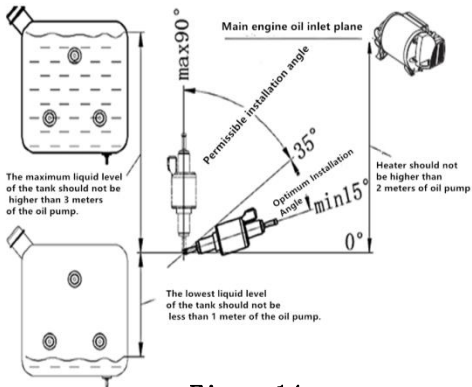

Figure 14

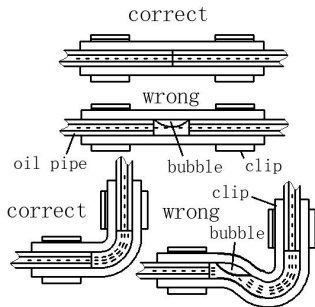

Figure 15

Installation of Fuel Filter

Install a fuel filter in front of the oil inlet of the oil pump.

During installation, pay attention that the fuel filter must be vertical and upward (ensure that impurities deposit downward).

The replacement cycle of fuel filter is two years, and the oil pipe connector and clip must be replaced at the same time.

Installation of oil intake nozzle (Figure 16)

Firstly, the oil intake nozzle is fitted with O-ring, and then it passes through the bottom hole (self-processing) through the inside of the tank. Put gaskets on the outside of the tank and tighten them with nuts. The tightening torque is $6Nm+1Nm$. The O-ring must be clamped between the

inner wall of the tank and the oil intake nozzle to ensure good sealing between the oil intake nozzle and the oil tank. (Accessories such as oil intake nozzles are attached to the tank)

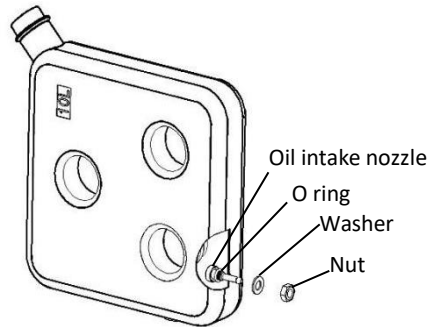

Figure 16

Installation of suction pipe (Figure 17)

Used when drawing fuel from the fuel tank of the vehicle. It must be installed from the upper surface of the oil tank, not from the side of the oil tank. During installation, attention shall be paid to the size of the installation opening on the oil tank (or oil tank cover) $\phi 25 \pm 0.2$, with neat edges and flat surroundings to ensure good sealing with the oil suction pipe seat. The distance between the lower opening of the oil suction pipe and the bottom of the oil tank should be 30-40mm, which can not only ensure the full absorption of fuel, but also prevent the impurities deposited at the bottom of the oil tank from being sucked in.

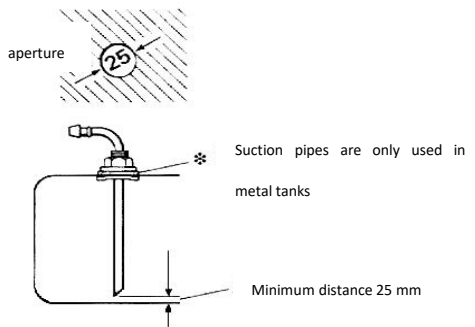

Figure 17

The connection of water pipe

A pressure pump or submerged pump with a pressure of 2.8 bar can be used to supply water to the water tank. If the water tank is connected to a centralized water supply (rural or urban connection), or if a high-pressure pump is used, a decompress or must be used, which will prevent pressure above 2.8 bar.

★ before the pressure relief valve is triggered, the temperature rise and expansion of water may cause a pressure of up to 4.5bar. The water pipes connected to the water tank and the safety / drainage valve must be water pipes with safe drinking water, pressure resistance of more than 4.5bar and hot water resistance of more than 80 ° C.

Pressure relief valves must be installed (Figure3-36, 0.35MPa) .If there is too much pressure in the system, the pressure will automatically be released intermittently through the relief valve.

Be careful!

When the water tank is externally connected with the reducer quick connector (single option in Fig. 3-35), it is necessary to manually pull it after installation to ensure that it is installed in the water pipe slot. When installing the water tank exhaust valve (single option in Fig. 3-19) with manual force (no additional tools), it is necessary to increase the sealing gasket (single option in Fig. 3-21). Avoid unnecessary damage to the exhaust valve of the water tank, which may affect the normal use.

The external steel pipe of the water tank shall not be hung with redundant accessories (the user shall take necessary measures to prevent it from being subjected to excessive gravity), so as to avoid unnecessary damage to the water pipe interface caused by excessive turbulence and water leakage.

Installation of External Temperature Sensor

It is installed in the vehicle to measure the room temperature. The installation position of the sensor is determined by the RV manufacturer according to the specific situation of the vehicle. When selecting the installation position, please note that the external temperature sensor should not be subject to direct thermal radiation.

For optimal room temperature control, it is recommended to install an external temperature sensor above the entrance door.

Please ensure that the external temperature sensor is always installed on the vertical wall and there must be free flowing air around it.

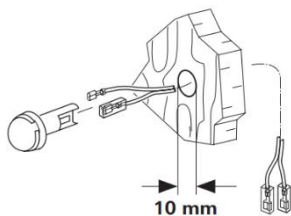

Figure18

Drill a hole with a diameter of 10 mm. The terminal passes through the opening from the rear, connect the end of the cable to the sensor as shown in FIG. 18 (it is not necessary to observe the polarity), slide in the external temperature sensor, and connect the two insulated connection plugs at the end of

the cable to the heater Electronics (if necessary, extend the cable to a maximum length of 10m, 2 × 0.5 mm² cable).

Note: the external temperature sensor provided must always be connected, otherwise the heater will switch to the fault state.

Electrical Connection

Lay wires to avoid scratches. If there are sharp edges, such as metal panel threading, please use lead bushing or edge protection accessories. Connector cables shall not adhere to or touch metal surfaces, exhaust pipes or hot air pipes. The electrical connection socket is located below the controller cover. The controller cover can be removed by pressing and sliding along the arrow at the same time. When removing or installing the controller cover, make sure that the connecting cable is not pulled out or squeezed.

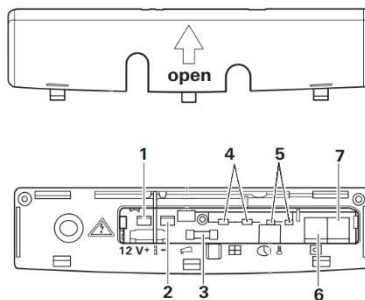

- 1- DC12V positive electrode
- 2- DC12V negative electrode
- 3- Fuse
- 4- Window Switch
- 5- External temperature sensor
- 6- 7-control switch

Figure19

When the window switch is not installed, the short wiring cannot be removed. All cables connected to the heater should be poked in a sagging direction. This prevents condensate from slipping off the connector cable and entering the heater.

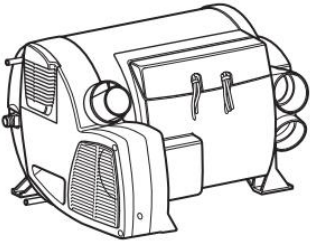

Figure20

Connector cables and plugs must not be subjected to force.

(Figure21), Tie connector cables and fasten them to the housing with straps to eliminate tension.

All cables must be firmly connected together. They should not be loosened or disconnected by vibration, resulting in fire hazards!

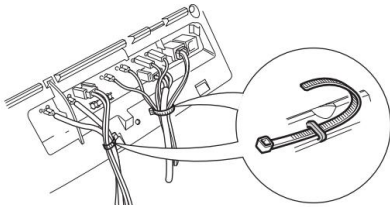

Figure21

DC12V Power

The electric circuit, switch and control equipment of the heater must be located in a position that will not adversely affect its operation under normal working conditions. The heater has reverse polarity protection. If the controller is not properly polarized, the LED indicator will not work.

The length and cross-sectional area of the power line shall ensure that the allowable voltage drop is not greater than 0.5V and 1.0V when the voltage is 12V and 24V. It is recommended to configure the power cord according to the following table.

Plus cable + minus cable	cross section
<8m	2.5mm ²
8~12m	4mm ²
12~16m	6mm ²

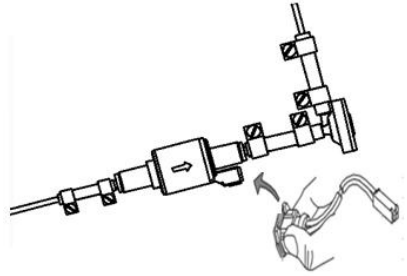

Figure22

Make sure the plug is firmly connected.

Electrical connection of oil pump

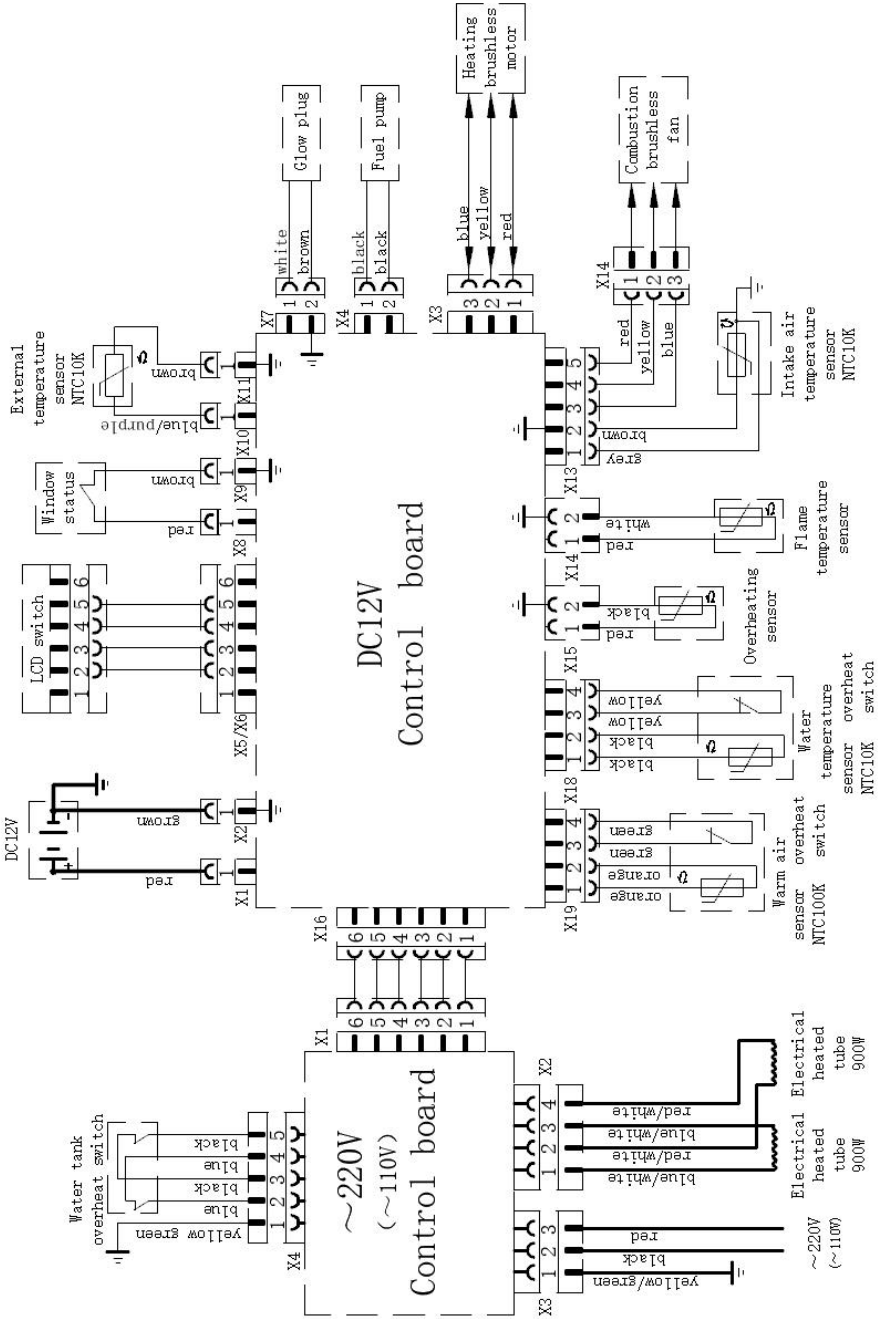

Figure 23

6. Operating precautions

Heaters are not allowed to operate during refueling or in enclosed spaces (enclosed parking lots, repair shops or ferry compartments). Check regularly whether the intake and exhaust pipes are in good condition and the fixing is reliable, especially after a trip. Also check the fixing of intake and exhaust pipes and smoke caps.

When black smoke is found, the company's authorized professionals are requested to carry out the inspection. Ensure that the exhaust pipe and intake pipe at the smoke exhaust cap are free from blockages such as snow, ice and leaves. Warm air outlet and circulating air inlet are unobstructed to avoid overheating of heater. In the case of overheating, the overheating switch will immediately cut off the fuel supply.

12V Fuse

Replacement with exactly the same fuse T20A is allowed only.

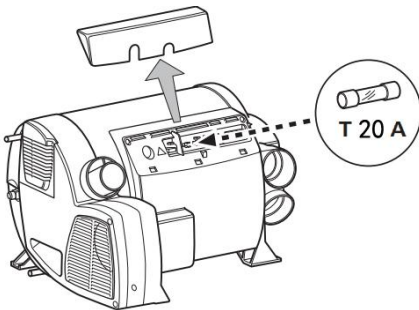

Figure24

★ Fuses and wiring harnesses must be replaced by professionals authorized by the Company.

★ All power supply must be disconnected before opening the control housing.

Fuse Specification: T10A/220V(20A/110V) Slow Fuse

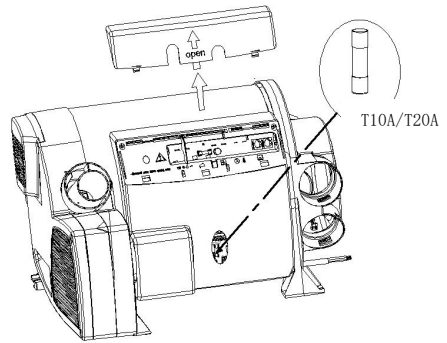

Figure25

~220V/110V Overheat protection

The utility heating function has an overheat protection switch. If the water tank of the heater is overheated, the overheat protection switch will be triggered and the heater will stop working. After the water tank temperature decreases, the overheat protection switch will automatically reset without manual reset.

~220V/110V Fuse

7. Operational instructions

Please read the instructions carefully before operation.

Start-up heater

Use special liquid crystal switch to operate.

The fuel oil, mains power, hybrid mode, heated water tank or unheated water tank for the main engine heating are all set according to needs.

Check the power supply capacity of RV camps, and choose the operation mode of 900W (3.9A/7.8A) or 1800W (7.8A/15.6A) accordingly.

--Check whether the smoke exhaust is unobstructed.

--The tank is full of water when needed.

Check that the safety valve / drain valve is closed

Turn on the circulating water pump, turn on the hot water faucets in the kitchen and bathroom until the air is discharged and the water tank is filled, and the water outlet is not interrupted.

If the heater is connected to the central water supply system (rural or urban water supply system), a pressure reducer must be used to prevent the pressure from exceeding 2.8bar (0.28mpa).

Turn off the heater

Use the special LCD switch to operate and turn off the heater. After that, the combustion supporting fan and the heating fan will continue to work for several minutes according to the temperature of the furnace body.

Heater drain

In case of freezing danger, the water tank must be emptied.

Turn off the power of the circulating water pump and turn on the hot water faucets in the kitchen and bathroom.

Open the safety / drain valve, and the heater will be directly discharged to the outside through the safety / drain valve.

Check whether all the water in the heater has been discharged into the container through the safety / drain valve (Note: 10L water bucket can be used to check the water to ensure that the water tank is empty).

No claim shall be made for the damage caused by frost during the warranty period.

Maintenance/repair/cleaning

The device can only be repaired and cleaned by professional personnel.

If new equipment is available, or the equipment has not been used for a long time, rinse all hot / cold water hoses thoroughly before use.

8. Failure

8.1 General Failure Handling

8.1.1 During the use of the heater, it may appear that it cannot start normally or turn off it after starting and is in the fault lock state. At this time, the heater can be turned off for more than 5S and restart.

8.1.2 The heater may cause circuit failure due to the following reasons: connector corrosion, poor contact, wrong insertion, wire or fuse corrosion, battery pile head corrosion, etc. pay attention to inspection and maintenance during use to prevent these phenomena.

8.1.3 When the following conditions occur, it can be handled and eliminated by the user:

- The heater does not start after the power is turned on and the LCD switch screen does not light. The reason is that the fuse is open, or the wiring is wrong. In addition, check whether the plug on the LED switch lead wire is properly connected to the host.

8.2 Fault Lock Status

8.2.1 The fault generated by the heater is indicated by the fault code on the LED switch.

8.2.2 The faults can be eliminated according to the methods listed in Table 2.

Fault Lock Status Debug Method		
Fault Code	Fault Name	Fault Debug Method
10	Over voltage fault	Check vehicle power supply system
11	Under voltage fault	Check vehicle power supply system
21	Warm air outlet temperature sensor disconnection	Check if the sensor is in good condition
22	Warm air outlet temperature sensor short circuit	Check if the sensor is in good condition
23	Water temperature sensor disconnection	Check if the sensor is in good condition
24	Water temperature sensor short circuit	Check if the sensor is in good condition
25	External temperature sensor disconnection	Check if the sensor is in good condition
26	External temperature sensor short circuit	Check if the sensor is in good condition
27	Combustion support temperature sensor disconnection	Check if the sensor is in good condition
31	Ignition failure	a. Check the fuel supply system b. Check whether the combustion air intake and exhaust ports are blocked c. Check glow plug and flame sensor
32	Combustion failure	a. Check the fuel supply system b. Check whether the combustion air intake and exhaust ports are blocked c. Check the flame sensor
33	Flame sensor fault	a. Check the flame sensor lead wire b. Check the flame sensor
34	Flame sensor open circuit	Check the flame sensor
35	Short circuit of flame sensor	Check the flame sensor
41	Warm air outlet overheats	Check whether air outlet is blocked
42	Warm air overheats switch protection	a. Check whether air outlet is blocked b. Check warm air overheat switch
43	Water overheat	a. Check whether the water tank is short of water b. Check whether the sensor is intact c. Check whether the air outlet is blocked
44	Water temperature overheat switch protection	a. Check whether air outlet is blocked. b. Check the water temperature overheat switch
45	Continuous overheat fault	a. Check whether air outlet is blocked b. Check the water temperature sensor c. Check warm air sensor
51	Communication fault	Check interconnecting cable

Table 2

Fault Lock Status Debug Method		
Fault Code	Fault Name	Fault Debug Method
61	Oil Pump Break	a. Check whether the oil pump lead is damaged or not b. Check whether the connection of oil pump leads is reliable. c. Refurbishment oil pump d.Replacement of motherboard
62	Short circuit of oil pump	a.Check whether the oil pump lead is damaged b.Check whether the connection of oil pump leads is reliable c. Refurbishment oil pump d.Replacement of motherboard
63	Glow plug open circuit	a.Check the power supply voltage b.2Check the normal temperature resistance of the glow plug (0.2 Ω / 12V) c.Clean the carbon deposits on the glow plug d.Replacement of motherboard
65	Glow plug (no drive)	Replacement of motherboard
81	Open circuit of combustion supporting fan	Check combustion air blower
82	Combustion supporting fan failed to start	a. Check the lead connection of combustion fan b. Check combustion air blower
83	Combustion support blower spindle speed too low	Check combustion air blower motor
84	Warm air blower motor disconnection	Check warm air blower motor
85	Warm air fan failed to start	a. Check the blower motor lead wire b. Check warm air blower motor
86	2The speed of warm air fan is too low	Check warm air blower motor
110	Window alarm	Check window switch interconnecting cable
120	Low voltage alarm	Recommended charging
220	220/110V Connectionless	Check AC 220V/110V power supply system
168	Watchdog reset	ignore
169	Abnormal power failure	ignore
224	No start signal	Replacement of motherboard
238	Unknown fault	ignore

Table 2 to continue

9. Operational Precautions

●Initial Installation

--The heater is installed for the first time. In order to completely eliminate the air in the fuel supply system and make the fuel pipeline full of fuel, a separate pump function is specially designed. See LCD switch instructions for details.

--Rinse the water tank with clean water before the heater is first installed and used. When the heater is not in use, please empty the water tank so as not to freeze the water tank. The company is not liable for damage to the water tank caused by freezing.

--Open the circulating pump.

--Open the hot tap in the kitchen and bathroom until the air is exhausted and the water tank is filled, and the water is not interrupted.

--The heater should be tested before use. During the trial run, all connections should be carefully checked for leaks and security conditions. If there is smoke emission, abnormal combustion noise or fuel gas odor, the heater should be closed and the fuse should be pulled out so that it cannot operate. It can only be used after being inspected and repaired by professionals.

--When the heater is first used, it may emit odor in a short time. This is normal in the first few minutes of operation, and it does not mean that the heater is out of function.

●Quarterly Maintenance

--Before each heating season, the following maintenance work must be carried out by professionals:

Check whether the air inlet and outlet are contaminated and foreign matter.

Clean the outside of the heater.

Check for corrosion and loosening of circuit joints.

Check whether the intake and exhaust pipes are blocked or damaged.

Check the fuel line for leakage.

●Long-term shutdown

--When the heater is not used for a long time, it should be run every 4 weeks for about 10 minutes each time to prevent mechanical parts such as oil pump and combustion-supporting air fans from failing to function (freezing).

--The inlet and outlet of heater must be kept free of blockage and dirt, so that the warm air duct is unimpeded, in order to prevent overheating failure.

--When replacing low-temperature fuel, the heater should run for at least 15 minutes to fill the fuel system with new oil.

●Heater life

--The heat exchanger of the heater cannot be used for more than 10 years. Upon expiration, it must be replaced by genuine parts and replaced by the heater manufacturer or its authorized agent.

--When the exhaust pipe of the heater discharges combustion exhaust gas for 10 years, it must be renewed with genuine parts.

●Other considerations

--Water tanks must be cleaned regularly, at least twice a year.

--In the process of transportation and storage, the ambient temperature of heater should not exceed the range of -40 ~85 ~C in order to prevent damage to electronic components.

--Only authorized customer service stations are allowed to install and repair heaters, and non-original parts are prohibited to avoid danger.

--The manufacturer is not responsible for the maintenance of the heater due to the failure to install and operate in accordance with the regulations.

--The heater must be turned off before refueling.

--When welding automobiles, the positive pole of the heater should be removed from the battery and grounded to prevent damage to the controller.

LCD Switch Instruction Manual

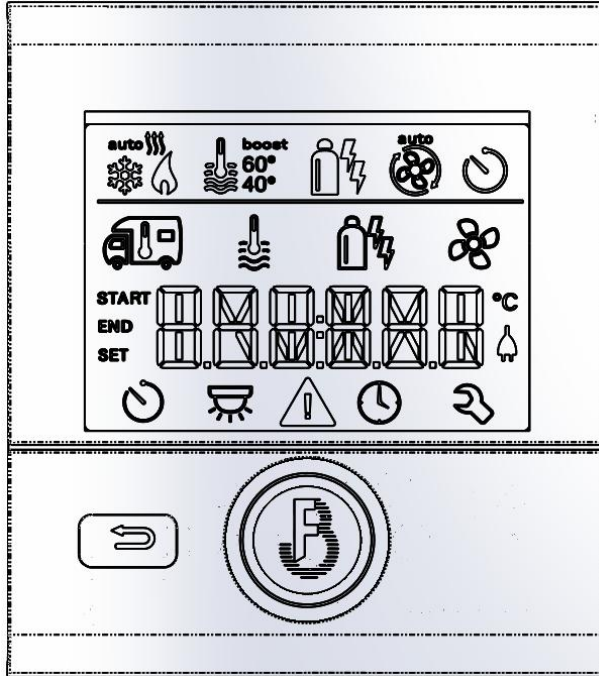

I. Display and control section

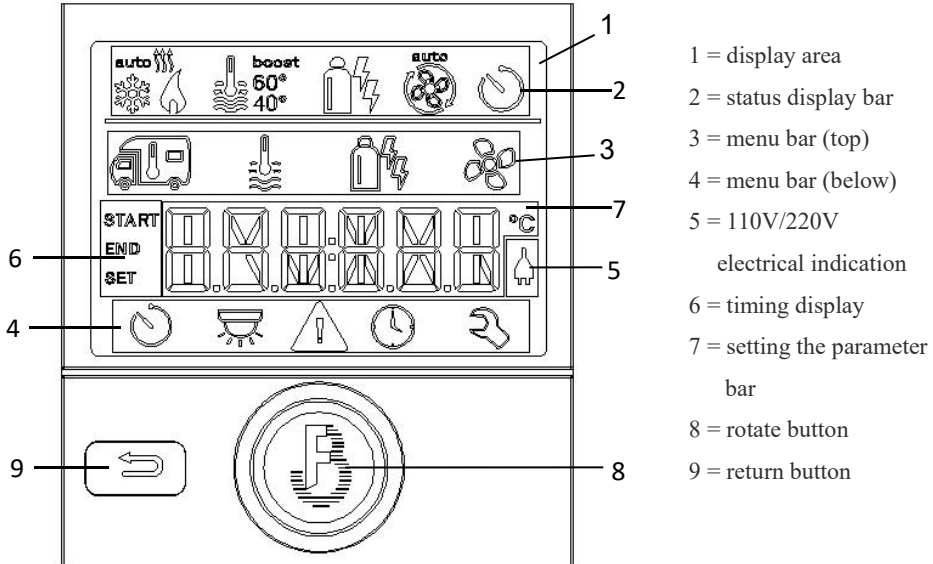

-- Information is displayed on an LCD with backlight.

-- In the menu bar (3, 4), the function of the LCD switch can be arbitrarily selected. The operating parameters are displayed on the status bar (2) and display (5, 6).

-- After the 220V is turned on, the 220V mains power supply indication column (5) displays the power supply sign.

-- During operation, set the parameter bar (7) to display the change between time and set room temperature.

-- Press the return button, the selected parameters are invalid and return to the previous interface.

Rotary Button

Select, modify and save the icons of menu bars 3 and 4 by rotating the button, and the selected icons flash.

Clockwise rotation indicates:

--Options scroll from left to right of a menu bar, to the end and to the front of another menu bar.

-- Add one to the value.

Counterclockwise rotation indicates:

--Options scroll from right to left on one menu bar, to the front end and then to the end of another menu bar.

-- The value is reduced by one.

Tap the rotary button to indicate:

--Select to confirm saving and return to the main menu.

Pressing the rotary button for a long time (more than 3s) indicates:

-- The heater heating function or other function is turned off and the LCD switch is turned off to enter the sleep state.

Return Button

-- Discard the current selection and return to the previous option.

II. Switch Setting

1. Power On

After a few seconds, the time is displayed at 00:00.

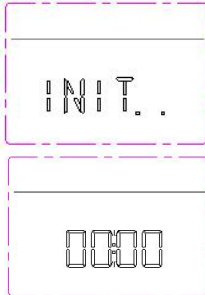

Click the rotary button to display the initial interface options in the display area.



Clock setting (current time setting)

Click the rotary button to display the icon in the menu bar (3).

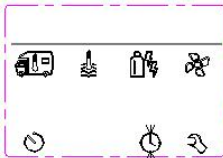

-- Use the rotary button to select the "Set Clock" icon in the menu bar (4).

-- Click the rotary button to enter the clock settings.

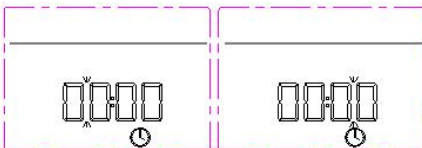

-- Use the rotary button to set the time. "A--" is displayed in the morning and "P--" is displayed in the afternoon, and it is automatically switched.

-- Click the rotary button again to determine the time, then the minute display flashes.

-- Set the minute with the rotary button.

-- Click the rotary button to confirm the value and exit the clock setting.

2. Rotate button to start

-- Press the rotary button for a long time (more than 3s), the LCD will start.

3. Shutdown

Press the rotary button for more than 3s at the initial interface to shut down. When the LCD switch is turned off, the heating process and any connected equipment are also automatically turned off. The parameters before shutdown are retained.



Downtime Process

Since the heater has a higher residual heat after heating and a post-cleaning need (combustor after combustion), the fan typically runs for a few minutes for cooling.

III. Heating Function Setting

The heating function setting should first set the energy, and then select water heating or room heating or simultaneous heating, and finally set the circulating wind speed. The default heating function settings is the energy setting fuel and the circulating wind speed setting eco.

1. Energy Setting

Rotate the button to select the energy icon in the menu bar (3).

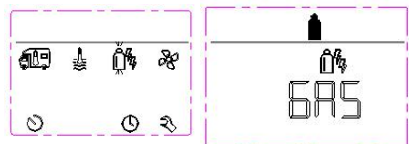

- Click on the selected icon.
- Use the rotary button to select the desired energy mode.
- Click the rotary button to confirm.

Working Mode	Energy Mode
GAS	Diesel
MIX 1	electrical 900 W+GAS
MIX 2	electrical 1800 W+GAS
EL 1	electrical 900 W
EL 2	electrical 1800 W

If the energy type is not selected, once the heater starts to operate (room temperature, hot water icon is activated), the status bar shows the type of energy selected during the previous heating process or the energy type gas set at the factory.

2. Adjustment of Indoor Temperature

Click the rotary button to display the icon in the menu bar (3).

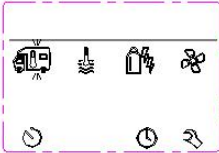

- Select the room temperature heating system with the rotary button according to the connected device.
- Confirm the selection by clicking the rotary button on the selected room temperature icon.
- Use the rotary button to select the desired temperature.
- Click the rotary button to confirm its value.

Temperature Display: °C degrees Celsius

Adjustment Range : 5~30°C

Stepping: 1°C

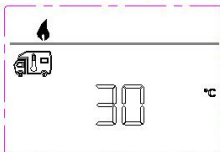
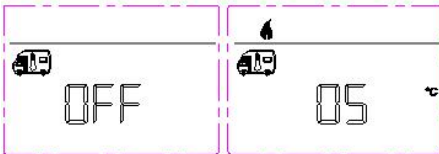

Flame icon = room temperature heating start, this icon will flash until the predetermined room temperature is reached.

3. Adjustment of Water Heating

Click the rotary button to display the icon in the menu bar (3).

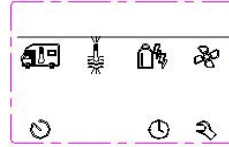

- Use the rotary button to select an icon in the menu bar (3).
- Click the rotary button to confirm and enter the setting level.
- Use the rotary button to select the desired water temperature setting level.
- Click the rotary button to confirm the value.

Work Mode	Description
OFF	Water heat is turned off. Water heating icon disappear
ECO	scheduled water temperature target 40°C
HOT	scheduled water temperature target 60°C
BOOST	preferentially heats the water for 40 minutes or the water temperature reaches 60°C.

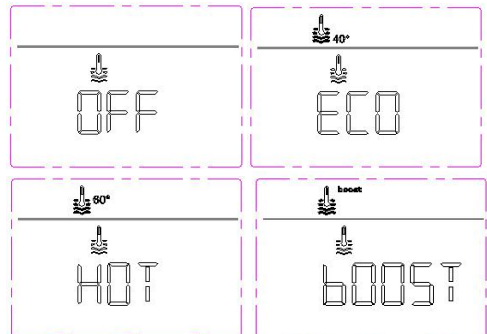

This icon will flash until the predetermined water temperature is reached.

In the "heating and hot water mode" the water temperature of 40°C can only be stored for a limited time (room heating priority).

4. Choice of Wind Speed

Click the rotary button to display the icon in the menu bar (3).



- Rotate the button to select an icon in the menu bar (3).
- Click the rotary button to confirm and enter the setting level.
- Use the rotary button to select the desired fan speed.
- Press the rotary button to confirm and save.

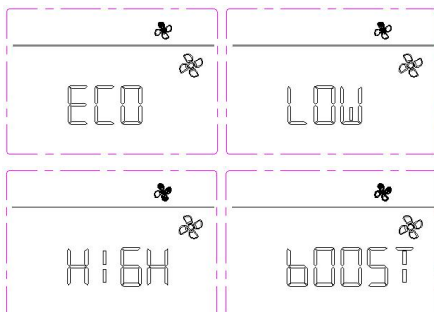

5. Start Heating

After the setting is finished, press the return key or wait for 10s to enter the clock interface, and the heating starts. The clock and set temperature are displayed alternately.

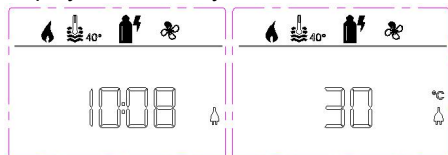

6. End Heating

Press the rotary button for more than 3 seconds to shut down.

iv. Timing Heating Settings

Click the rotary button to display the icon in the menu bar (3). Click the rotary button to enter the timing settings.

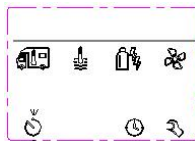

Warning: Danger of toxic exhaust gases.

Even if the vehicle is stopped, unmanned, the activated time switch will turn on the heater. Exhaust gases from heaters may be toxic in confined spaces such as garages, workshops, and repair shops.

If the vehicle is parked in a closed room:

Work Mode	Description
OFF	Turn off the fan.
VENT	Circulation ventilation, you can choose 10 levels Wind speed. May increase the abrasion of the motor, depends on how often it is used.
ECO	Low wind speed
LOW	Mid-speed
HIGH	High wind speed results in higher power consumption, higher noise levels and increased motor abrasion.
BOOST	Room heats up quickly

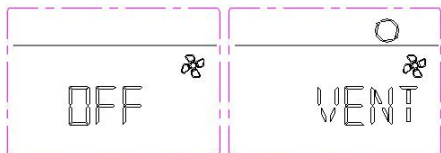

- Turn off the fuel supply to the heater.

-- Turn off the timer switch of the LCD switch.

-- Turn off the heater on the LCD switch. Press the rotary button for 3 seconds to turn it off.

1. Enter the Startup Time

Use the rotary button to set the start time. Click the rotary button to confirm and proceed to the next setting.

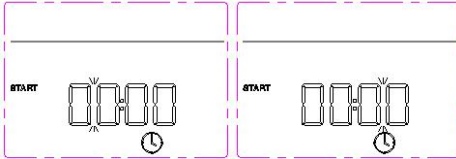

2. Enter the End Time

Use the rotary button to set the heating end time. Click the rotary button to confirm and proceed to the next setting.

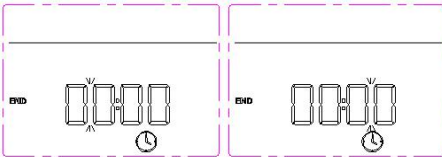

3. Set the Room Temperature

Use the rotary button to select the desired room temperature. Click the rotary button to confirm the value.

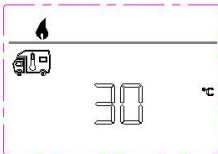

4. Set the Water Temperature

Use the rotary buttons to select the desired hot water level. Click the rotary button to confirm.

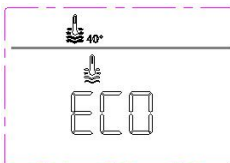

5. Energy Mode Selection

Use the rotary buttons to select the desired energy mode. Click the rotary button to confirm the value.

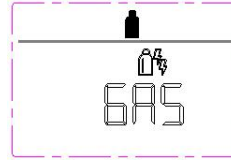

6. Select Fan Speed Grade

Use the rotary buttons to select the desired fan speed level. The fan speed rating is selected only after the room temperature heating mode is set. Click the rotary button to confirm.



7. Timing Enabled

Use the rotary button to select Enable Timing (ON). If OFF is selected, the timing is canceled, but the settings are saved. Click the rotary button to confirm that the timing is valid.

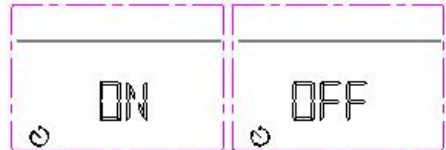

The time switch is only enabled once until it is disabled (turned off) or powered down. If the time switch is programmed and enabled, the time switch icon is displayed in the status line (2). The timing icon flashes if the time switch is enabled and activated.

8. Cancel Timing

With the timing set, use the rotary button to select the timing setting. Click the rotary button to enter the settings.

Use the rotary button to select the cancel timing (OFF). If you select ON, continue to use timing. Click the rotary button to confirm that the cancellation timing is valid. But the previous settings are still saved.

V. Parameter Settings

The content after the parameter setting is maintained after the power is turned off. Use the rotary button to select the "Settings" icon in the menu bar (4). Click the button to enter the settings.

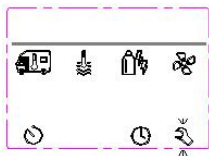

1. Voltage inquiry

Click the rotation button to display the voltage: 12.0V.

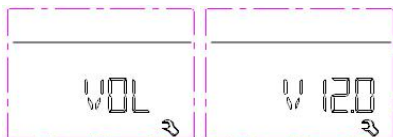

2. Air pressure and temperature inquiry

Use the rotate button to select the ATMOS icon.



Click the rotation button to enter the query.

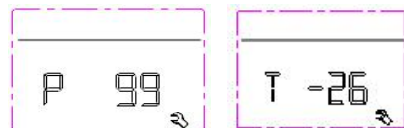

Use the rotary button to switch between atmospheric pressure and ambient temperature.

Atmospheric pressure: 99KPa

Ambient temperature: -26 °C

3. Offset Setting

The external temperature sensor of the heater can be adjusted separately depending on the installation of the sensor. The offset setting can be in the range of -5°C to 5°C. The deviation is 1°C. Use the rotary button to select the

OFFSET icon and click the rotary button to enter the settings. Use the rotary button to select the offset value. Click the rotary button to confirm and save.

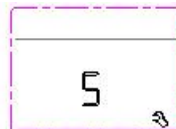
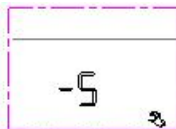

4. Switching temperature units

Use the knob to switch between centigrade and Fahrenheit, and click OK.

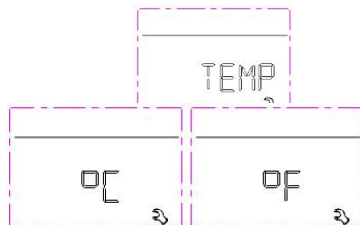

5. LCD Backlight Adjustment

The LCD backlight has 10 levels of incremental adjustment. Use the rotary button to select the BRIGHT icon and click the rotate button to enter the settings. The brightness of the LCD changes as the rotary button rotates. After confirming by clicking the rotary button, return to the previous operation. The backlight brightness is set to 6 by default.

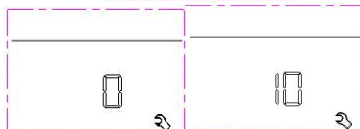

6. Set the Time Format

Use the rotary button to select the time format setting icon and click the rotary button to enter the settings. Use the rotary button to select the 12h or 24h icon and click the rotary button to confirm. The default setting is 24h.

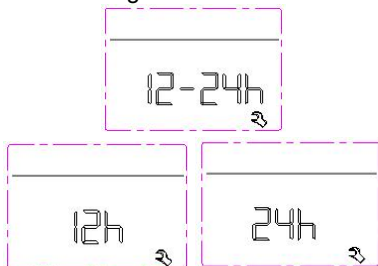

7. Fast Pump Oil Settings

Select pump oil icon GoOil with rotary button.

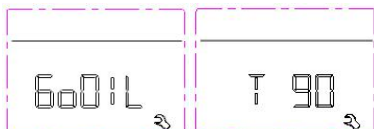

Click on the rotary button to enter the fast pump oil. The default fast pump time is 90 seconds. The remaining time can be adjusted with a knob.

Press the return key or stop the fast pump if the pump oil time exceeds the set value.

Click the rotate button or return key to return to the previous operation.

8. Software Version Number

Use the rotary button to select the INdEx icon and click the rotary button to enter the query item. Use the rotary button to view the information of the LCD switch or the information of the main controller.

Click the rotary button or want to go back to return to the previous operation.

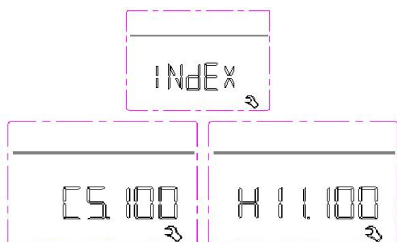

C5.100-- LCD switch version
H11.100-- master controller version

9. Factory Setting

The reset function resets the LCD switch to factory settings. All previous settings will be deleted. All devices used before RESET is installed and powered.

Use the rotary button to select the RESET icon and click the rotary button to display the factory setting PR SET.

After confirming, the initialization "INIT....." is displayed.

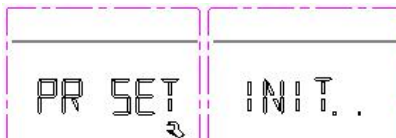

10. Bluetooth on / off

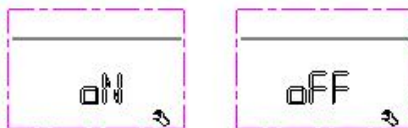

11. Extended functions



vi. Fault Display

How to Read the Warning Code:

-- Use the rotary button to select the icon  and click the rotary button to display the current warning code (for troubleshooting, please refer to the relevant heater instruction manual).

There are faults in the fault that are automatically recovered and manually recovered after repair.

An automatic recovery fault is a warning fault in which an operating parameter has exceeded a defined normal working range and reached an undefined state. In this case, the device will continue to run and the warning symbol (!) will be displayed in the menu bar (4) without warning code. After the fault is repaired, the warning symbol disappears automatically (it can also be manually restored), and the device continues to work according to the original settings. For example: warning fault code W 120 H.



A manually recovered fault means that the fault code is displayed in the parameter setting field (7) when the fault occurs. The cause of the fault can be determined and remedied by the help of the troubleshooting guide. The fault code disappears after a few seconds, and the warning disappears, and the warning symbol is displayed in the menu bar (4). Select Reheat after the fault is identified and resolved, first remove the fault code. Press the rotary button to display the fault code, then press the rotary button, the displayed fault code disappears and return to the initial time interface. Re-enter the heating parameters to initiate heating. If the fault is removed, the heating will be normal or the fault will occur again. The LCD switch will jump to the "Fault" menu again, the warning symbol will be displayed again, and the affected device will still be in the

warning state. Since the fault has not been eliminated, if you want to return to the set level, press the back button (9). For example: fault code E 31 H. Shutdown and power off can also eliminate faults.



Refer to the instruction - Table 2 for the list of fault codes and troubleshooting methods.

VII. Technical Parameters

Display: LCD, black and white, with backlight.

Dimensions: 92×103×40mm

Working temperature: -25°C~60°C

Storage temperature: -25°C~70°C

Power supply: DC10.5~16V

Power consumption: Max.65mA (100% backlight)

Standard current: 10mA

Quiescent current: 3mA

The above parameters are subject to change without notice.

Maintain:

The LCD switch is maintenance-free. To clean the front panel, use a damp cloth or use a neutral soap solution.

VIII. Installation Instructions

Installation in vehicles must comply with applicable technical and administrative regulations.

Safety Information:

Installation and services must be performed by an authorized installer, service agent. Improper installation, alteration, repair will result in property damage, personal injury or loss of life and will void the warranty.

Don't try to install it yourself. Do not use high voltage equipment unless the electronic circuit (board) is disconnected. Do not use a battery charger to power the heater, even while testing. If the vehicle requires soldering, do not connect a 12-volt DC power supply to the unit.

Electric welding can cause serious damage to the equipment. Do not shorten the electrical connection cable or remove the label indicating polarity. Turn off the vehicle's onboard power supply during installation and turn off the power when the device is connected.

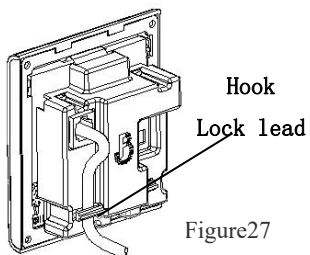

Figure27

Installation location:

Install the LCD switch in a waterproof and moisture-proof position. Install the LCD switch at the height of your eyes for easy reading and operation.

Prepare a mounting opening for the LCD switch, as shown in Figure 28.

Route the connector cable connecting the cables in a tension-free circuit. It must be possible to pull the liquid crystal switch out of the mounting hole by 20 cm so that no tensile stress is applied to the plug connection. Never drawing the connector cable when connecting to the LCD switch.

Assembly:

Install as shown in Figure 29. Install the LCD switch holder to the wall with 4 M3×10 screws.

- ① Hang the front panel of the LCD switch on the holder

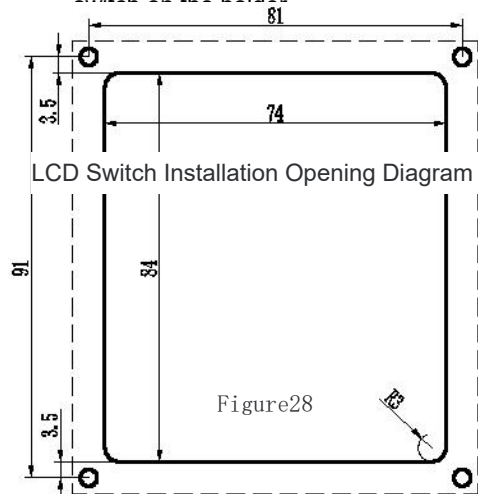

Figure28

Installation Method of LCD Switch

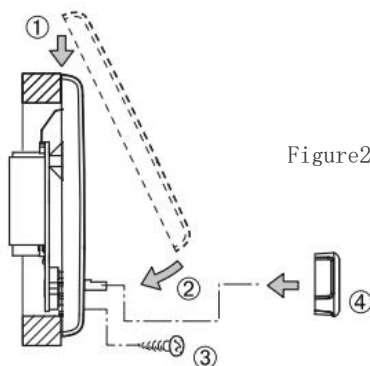
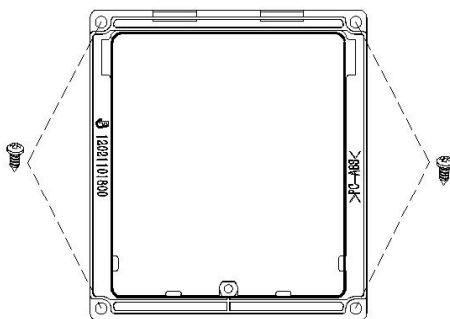

Figure29



IX. Accessories

Name	Quantities
·LCD switch	1
·Cross countersunk head flat tail self-tapping nail M3×6	1
(fastening the switch panel)	
·Cross head self-tapping nail M3×10	4
(installed on the wall)	
·Operation and installation instructions	1
·Connecting cable, length 6m	1